

For de Installer

INSTRUCTIONS FOR INSTALLATION

TRUE VISION **RUSTICA**

CLOSED GASFIREPLACES



Distributor/Manufacturer
M-Design Benelux BVBA
B-8210 Zedelgem - Belgium

V-2020-01



PASSION FOR FIRE

1. General remarks	3
2. Connection	3
3. Installing the fireplace	4
3.1. Positioning the fireplace	4
3.2. The gasunit.....	5
3.3. The gas connection	6
3.4. Electrical connection.....	6
3.5. Modification natural gas to propane (or inverse)	6
4. Installing the chimney)	7
4.1. Roof exit (C31).....	7
4.2. Roof exit via existing chimney (C91)	8
5. Isolation et finition	9
6. Convection.....	9
7. Contruction of interior in briquettes	10-11
8. Mounting of the window.....	12-13
9. Mounting tilting box	14-15-16
10. Woodset	17-24
11. Dimensions	25-26
12. Spare parts.....	27

1. General remarks

This is an appliance using the closed combustion system, designed for the atmosphere and comfort of your living-room. It constitutes an efficient source of heat and gives the impression of a real fire.

The balanced flue appliances are based on the principle of natural extraction from the firebox, which eliminates flue gas outside and brings in air (oxygen) from outside the house which is necessary for combustion of the gas. It uses to this effect two concentric pipes. The internal pipe ensures the elimination of burned gases and the external pipe brings in combustion air. The advantage of this principle is that the equipment works independently of the atmosphere which predominates in the house.

2. Connection

This appliance must be connected by an approved installer in accordance with the most recent

regulations in force. On the basis of your order specifications, this appliance is designed for natural or propane gas.

Read the instructions before installing and using this appliance. Before installing the appliance, please check the local regulations about this type of appliance (identification of the type of gas, etc.) and check that the furnace is adapted to your means of installation.

The appliance must be connected to the type of gas mentioned on the appliance. Never connect a propane burner to natural gas or vice versa!

The device is supplied with a concentric outlet of $\varnothing 200 / \varnothing 130$ as standard.

If due to circumstances (chimney configuration) an output of $\varnothing 200 / \varnothing 150$ is required, this can be specified when ordering.

It is imperative that the installer sees to the following:

- The appliance must be subject to an air tightness test of the gas and elimination of flue gases.
- The concentric pipe, if already available, must be working correctly.
- The running of the control valve, lighting of the pilot light, the main burner and the thermocouple must all be checked.

This appliance has been programmed and factory sealed. The sealed parts cannot be modified. The appliance may therefore also be installed in airtight accommodation and accommodation equipped with mechanical ventilation. It constitutes ambient heating even in accommodation equipped with a closed ventilation system.

3. INSTALLATING THE FIREPLACE

After having checked the appliance, you are ready to install your

3.1. POSITIONNING THE FIREPALCE

Place the appliance on a stable surface using the adjustable feet. Adjust the height of the appliance turning the bolt.

The appliance must not be placed directly on the floor as you need to allow air circulation underneath the appliances. Minimum height to floor = 21mm

Never place the fireplace directly against the wall. The wall part against which the appliance is placed shall be made of a fire-resistant material. If this is not the case, a fire resistant insulation board of at least 12 mm must be provided with a free space of 2 cm between the wall-wall insulation board and its appliance.

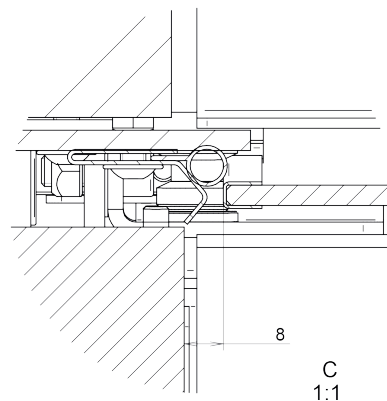
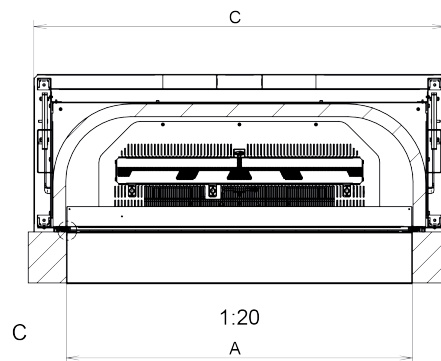
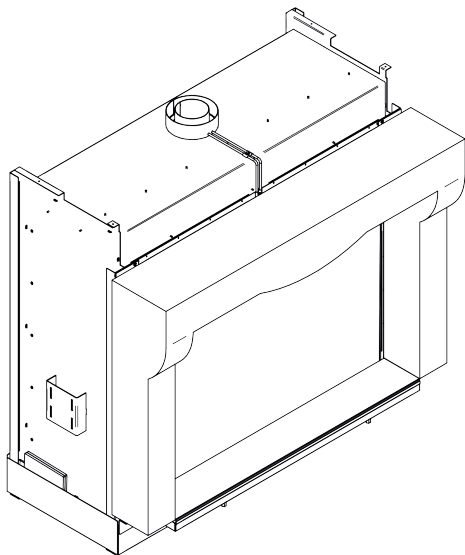
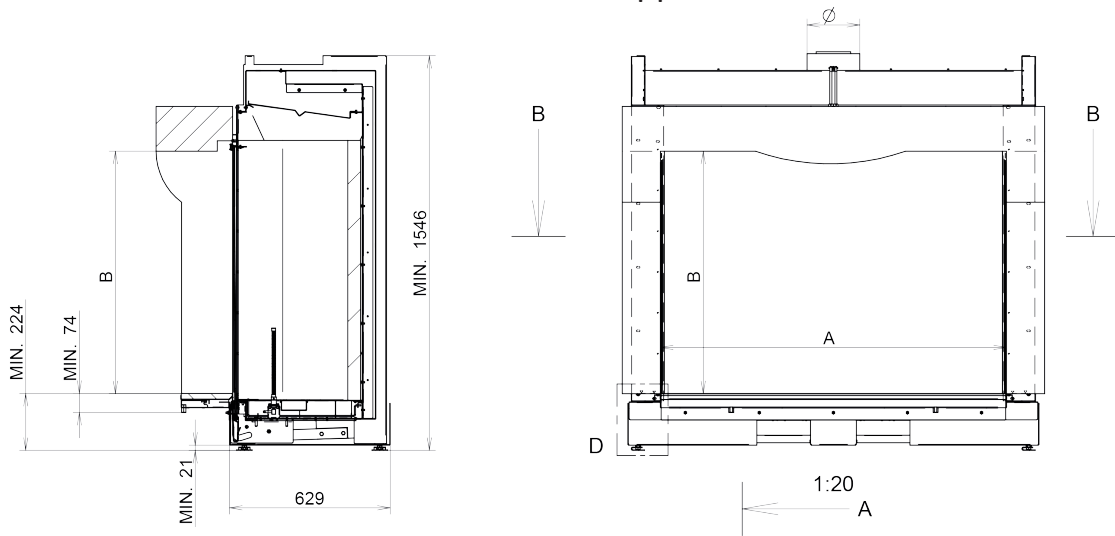

Type	A(mm)	B(mm)	C(mm)
Rustica M	850-995	800-1100	1311
Rustica L	1000-1175	800-1100	1461
Rustica XL	1180-1360	800-1100	1611

3.2. THE GASUNIT

For safety reasons, The gasbattery or "NEARBOX" is furnished in a box with the fireplace

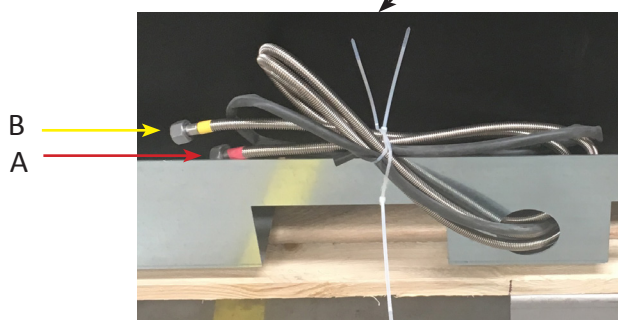
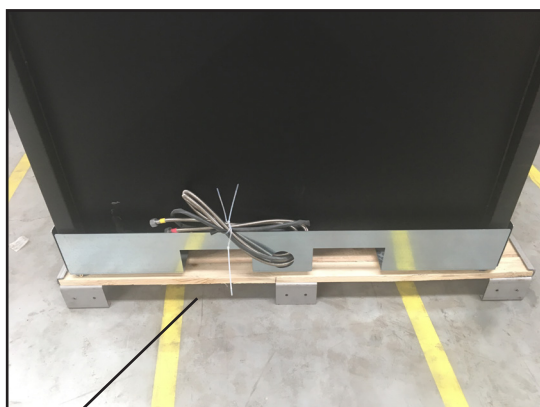

reciever
DFGT-03MC01 V09

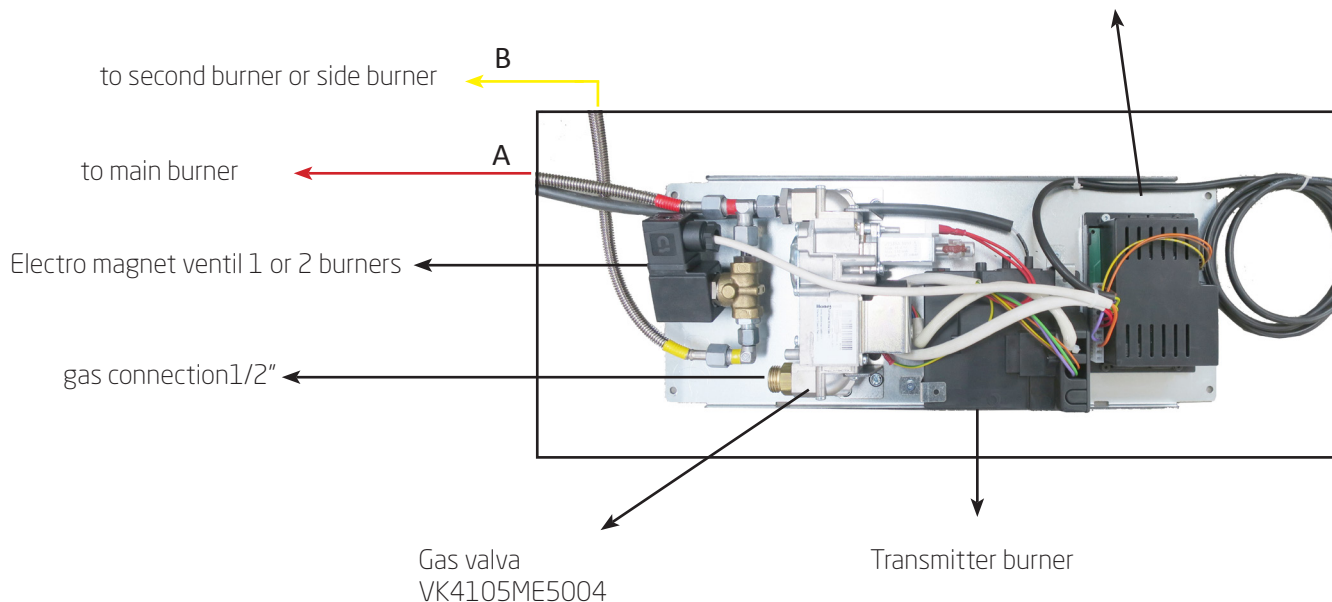

Dimensions gasunit : 455 x 188 x Height 64mm

3.3. The Gas connection

After the “NEARBOX” has removed from the of the back of the fire, you can place it loosely on the ground in proximity to the opening provided in the wall of mantelpiece. The device is always connected with an approved gas tap 1/2, and preferably with a yellow gasflexible that is reachable at all times. Provide the mantelpiece with a door so that the valve and the electrical connection is easily accessible.

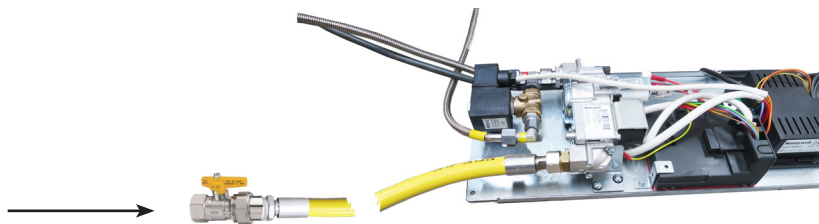
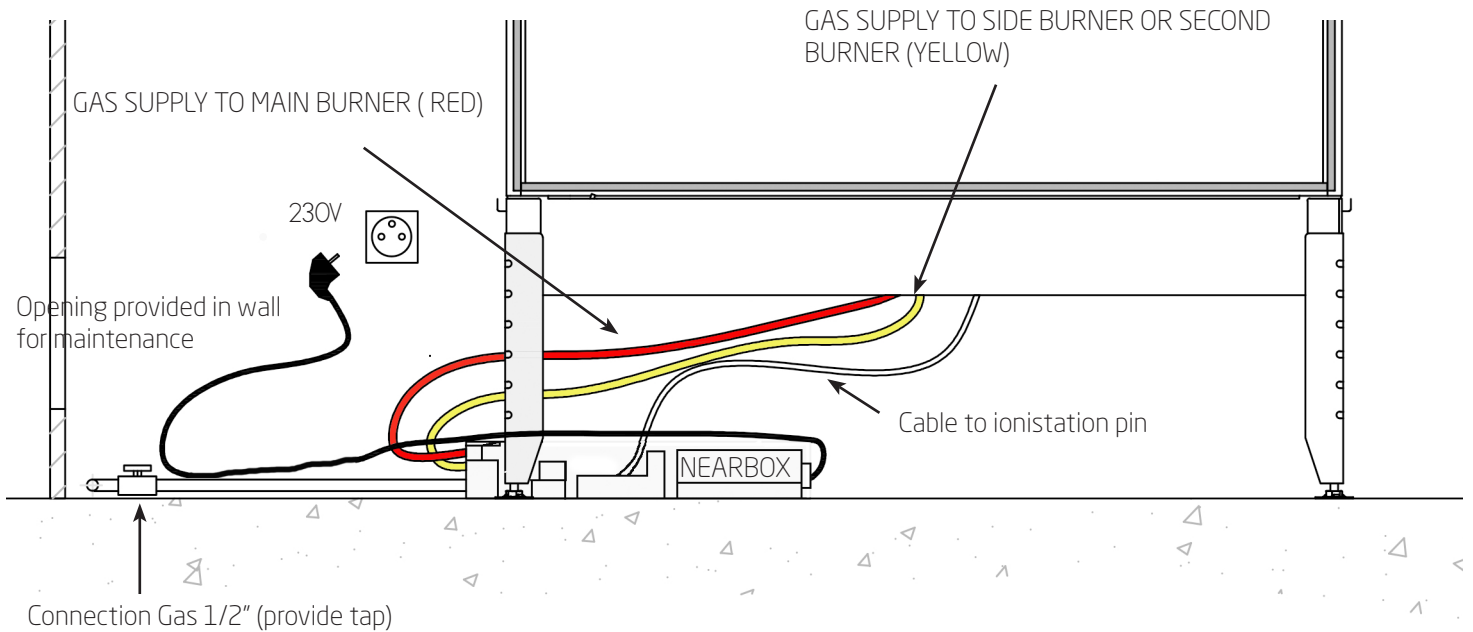

True Vision is provided with a direct ignition , no starting pilot



flexible for GAS



Valve 1/2"

3.4. Electrical connection

These appliances are equipped with a radiographic remote control, making an earthened 220V socket necessary. You should bear in mind that the appliance must be connected to all electrical supplies for the purposes of service. It's obligatory to connect an earth current.

3.1.5 Modification natural gaz to propane

Modification of the fireplace can only be done by the manufacturer or an approved installer. A new signal plate is provided.

4. Installing the chimney

Install the concentric flue duct as indicated by ONTOP- METALOTERM. The only authorised pipes are ONTOP Metaloterm™. ONTOP-METALOTERM tested our appliances with their conduct and we only guarantee a good working of the appliance with those. Between the external wall of the pipe and the wall or the ceiling, you should allow for a clearance of at least 50mm and protection that is suitable against temperatures of around 130°C. The passage of the front panel cowl in the external wall must be filled in using silicone mastic.

CAUTION: The concentric flue duct should not be reduced !!

CAUTION: Installing de Rustica is only allowed with roof exit. Never install the Rustica with wall exit !!

4.1. ROOF EXIT (C31)

One direction change of 2x45° is tolerated.
Never use 90° bends and horizontal sections.

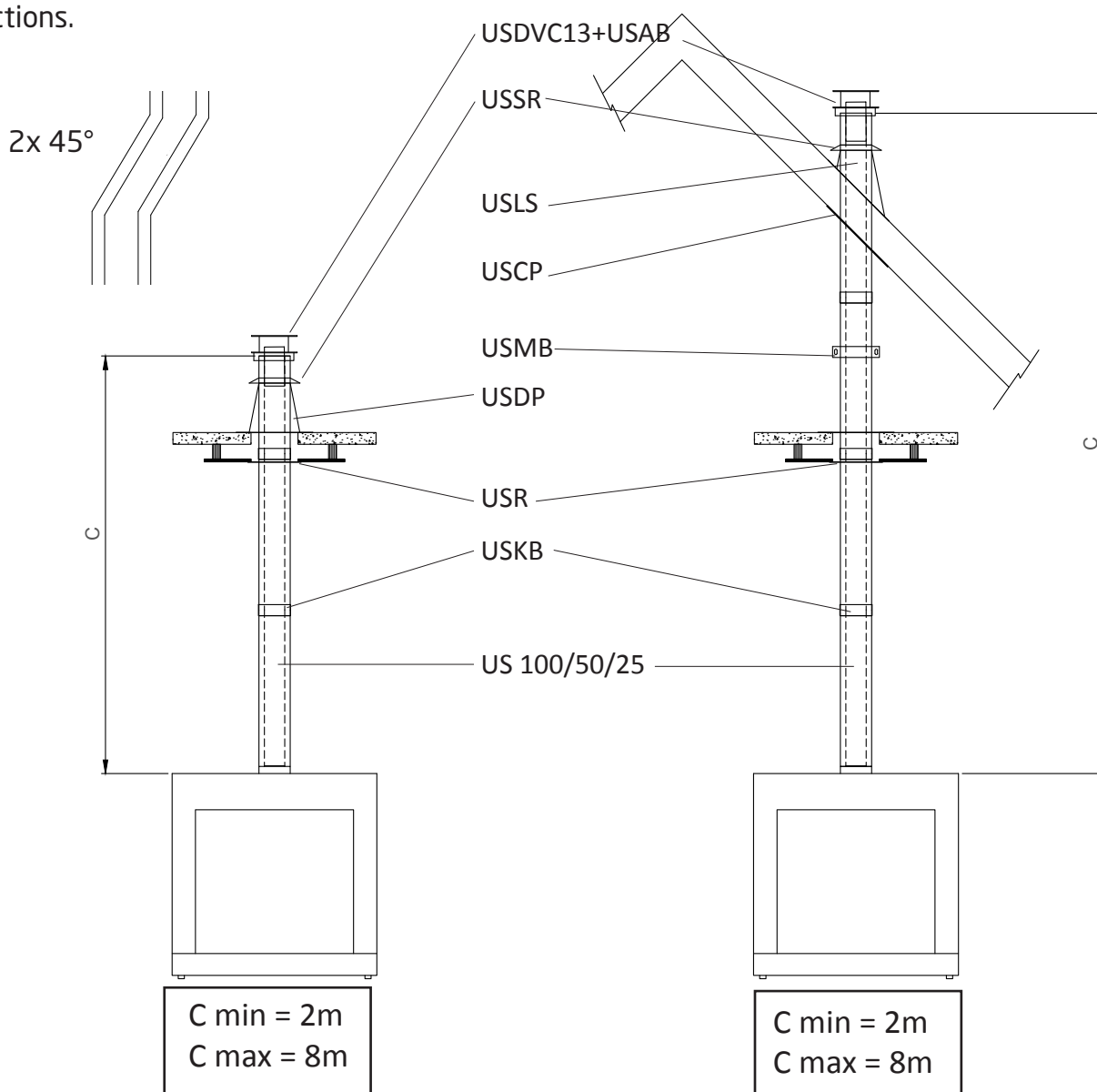

4.2. ROOF EXIT VIA EXISTING CHIMNEY (C91S)

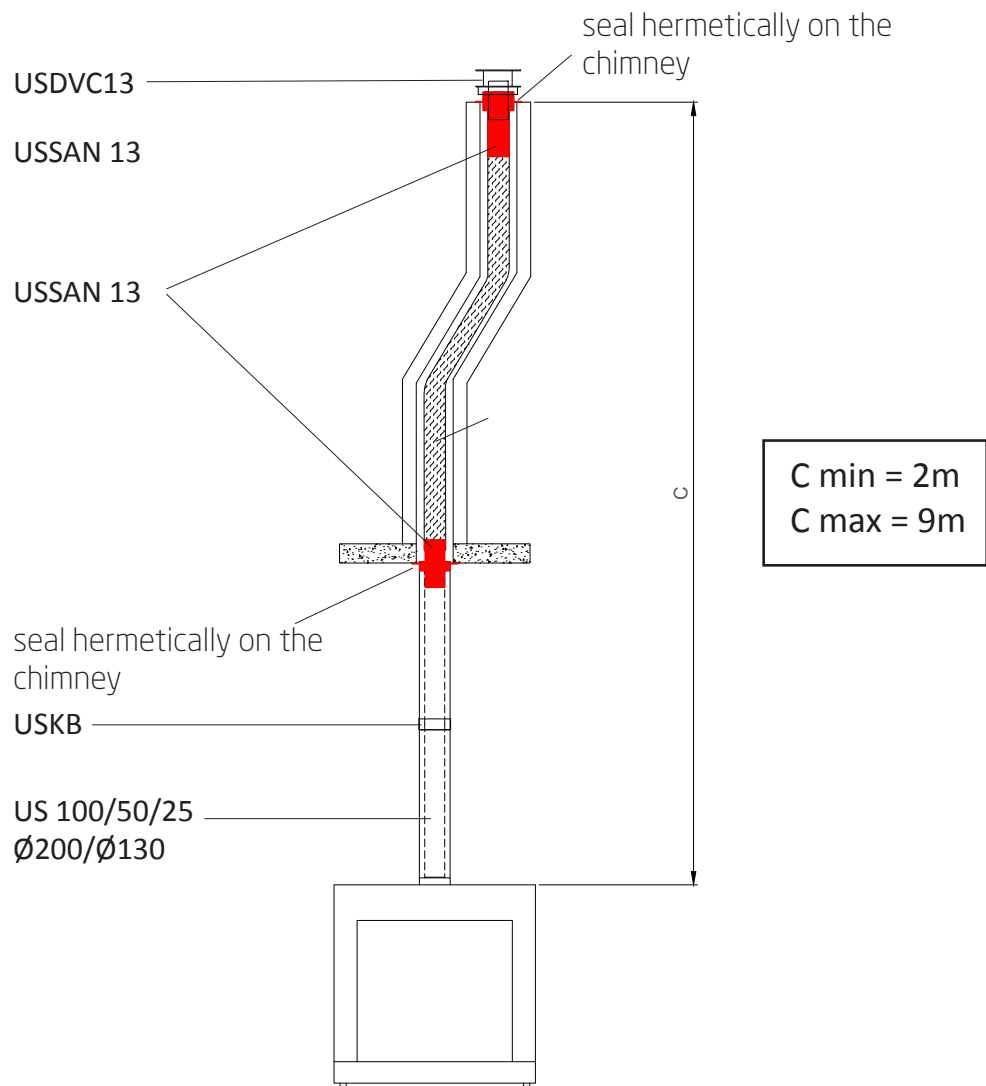

USSAN 13 sanitation kit: required when connecting to an existing chimney.

This one must be hermetically sealed to the ceiling and the USSAN13 on the top of the chimney must also be hermetically sealed at the exit.

CAUTION: It is imperative to sweep the chimney and clean it from dust and soot. The fireplace functions as an air inlet and if the fireplace is not clean, it will cause unpleasant odors.

5. INSLATION AND FINISHING

Masonry should be erected around the fireplace with a minimum distance of 4 cm between the fireplace and the finish. It is forbidden to put bricks or any other material on the fireplace. IT MUST BE TOTALLY DETACHED FROM ALL MATERIALS.

Now that installation is complete, the unit can be built in.

Before starting work, first check the gas tightness.

Start the fireplace and check its operation, the tightness of the gas pipes and the exit of the combustion gases. If these are in order, you can start the insulation and finishing work. The integrated part of the chimney becomes very hot. Therefore, make sure that the fireplace is not too narrow, but that there is enough room to extract hot air.

Do not isolate the device! Do not use glass wool or rock or other types of insulating materials (PVC, plaster, foam, ...). These cause fading and also annoying odors via the convection outlets. Never leave rubbish near the fireplace in the area where it is built in!!

6. CONVECTION

When installing the fireplace, a hot air outlet must be placed at the top left and right of the cabinet to dissipate heat in the area where the fireplace is located.

This is important for cooling the chimney in the chimney. There are no flexibles to install with True Vision Rustica.

7. CONSTRUCTION OF INTERIOR IN BRIQUETTES

The interior of the Rustica is rectangular, so you have two solutions, either to build your interior briquettes in a straight way or rounded in the corners reminiscent of the style of old fireplaces.

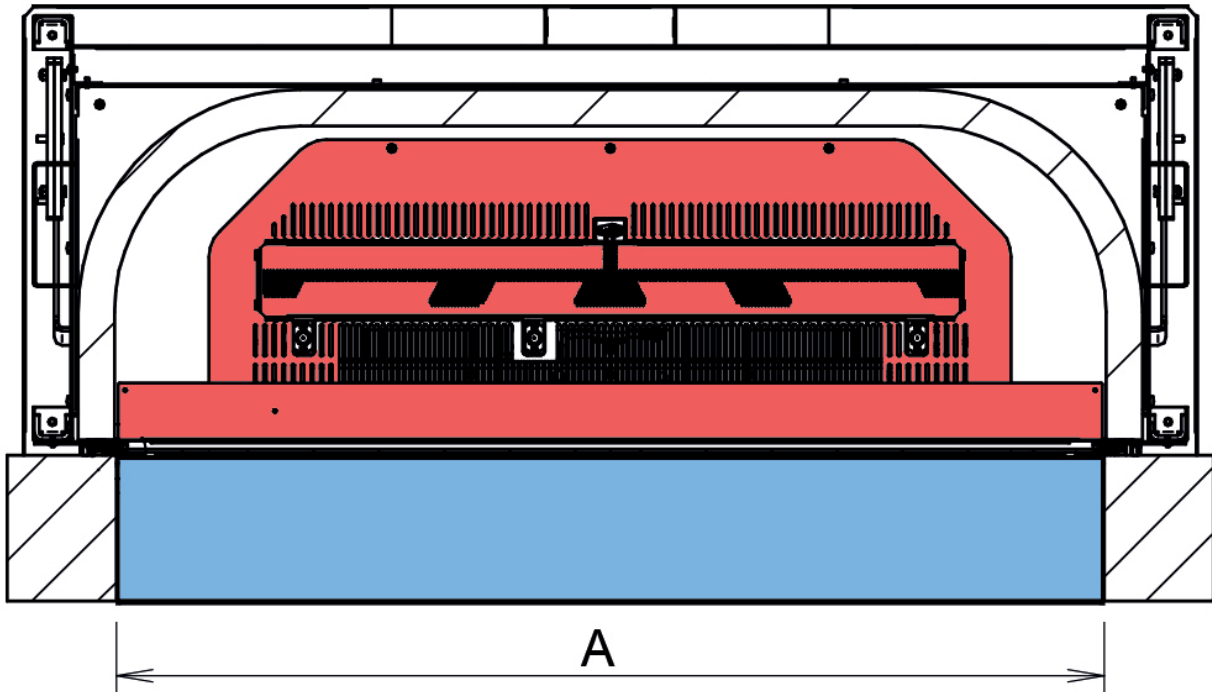

The briquetting must imperatively circumvent the central plate (red zone) to allow access to the burners and hearth.

The pivoting front plate (blue area) must also remain free to maintain its mobility. Build the cladding accordingly on top.

Use a high temperature resistant material



Finish against baffle and side profile



Tilting box finishing (4th removable side)

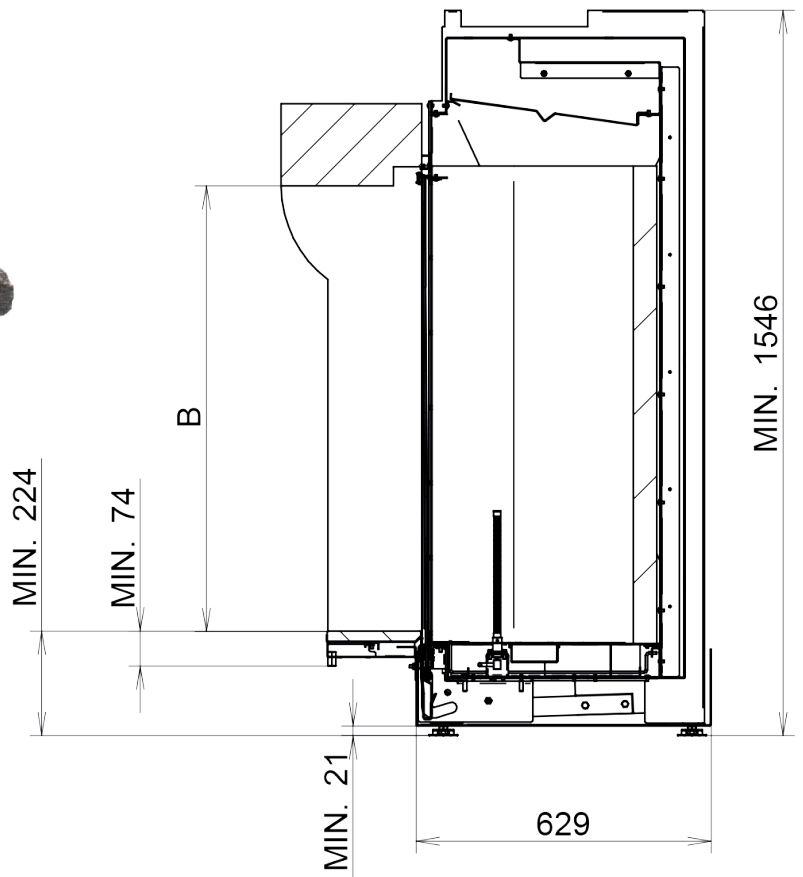
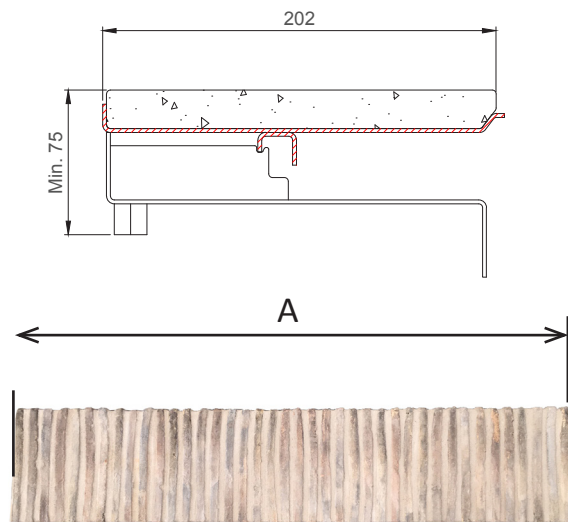

A-A

1:20

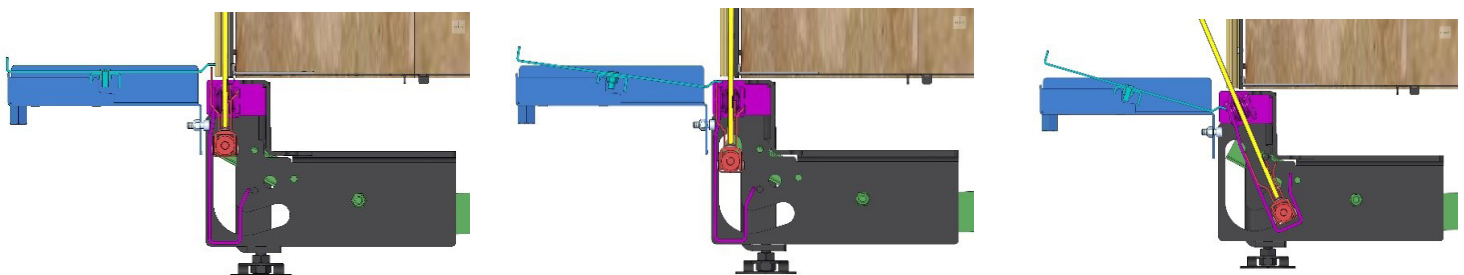

8. MOUNTING THE WINDOW

To protect the glass from breakage, it is supplied separately with the fireplace. We recommend that you mount the window once the unit is fully installed and boxed. Similarly, do not mount the window until you have finished the interior with the briquette decoration.

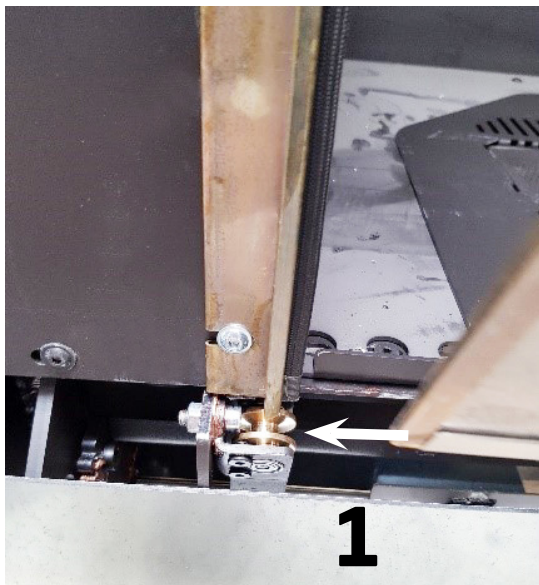

1. The door must be slid into the casters on the left and right.

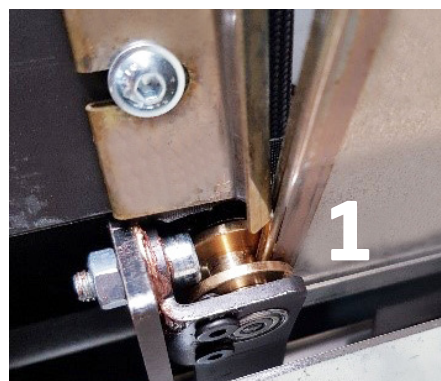
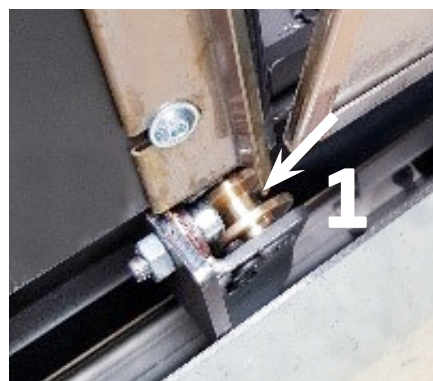

2. Push the door in the profiles, down

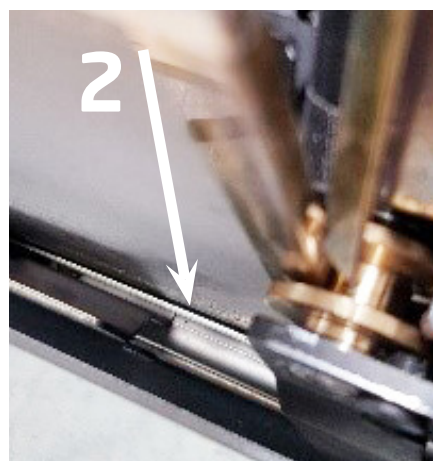

Keep the door open as much as possible and attach the support according to photo

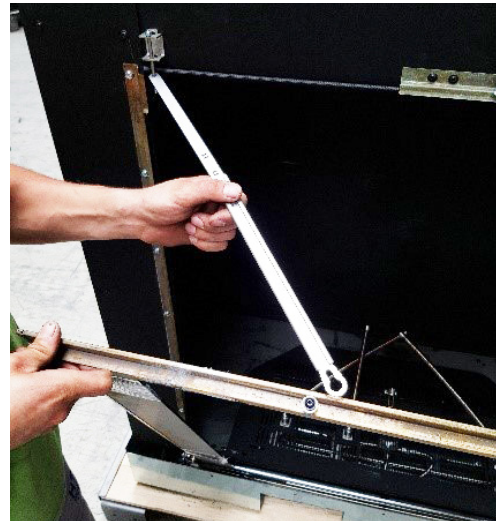

1. Close the door by pushing it down and toward the fireplace at the same time



2. Push the door against the fireplace.

3. The door goes up automatically and will be locked once she takes position behind the folded profile.



9. ASSEMBLY OF THE TILTING BOX

If you want to put a strip of bricks in front of the fireplace, you need to install a tilting box beforehand. Without this device, the glass will break with opening the door

The box is a free option and must be requested when ordering



Warning: do not install the box on a fireplace already equipped with a window or door with window.

Parts delivered with the tilting box::

1. black profiled sheet
2. tilting plate
3. Box
4. Nuts and screws



Deposit the profiled sheet in the fireplace according to the photo



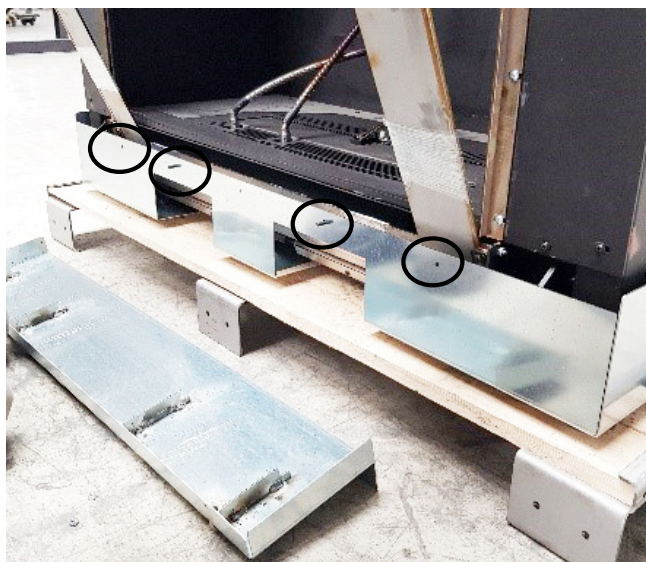

Use the bolts and nuts (supplied with the fireplace) to attach the box to the fireplace.



Use the long bolts (supplied with the fireplace) to level the box with the floor



Important: check the operation of the tilting box



Closed door: horizontal tilting plate



At the opening of the door, the tilting plate is inclined



Door fully open: the tilting plate must be slanted as in the picture

10. WOODSET TRUE VISION RUSTICA

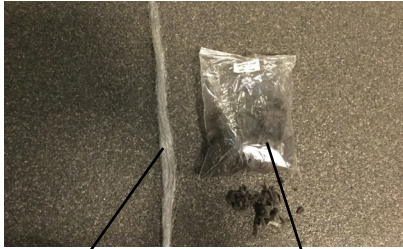

Angel's hair (unex glow)
+ 5 packets Imitation coal

WARNING:

Do not put anything on the ignition stem and in the rectangular area. In case the fire is not burning in first ignition after arranging of logs set, please open the window on the device and check if the electrode is clear and also the rectangular area around electrode is clear too. Subsequently after check repeat the ignition with opened window. When the fire burns evenly over the entire length of burners included secondary burners, the door can be closed. Repeat ignition one more time with closed window.

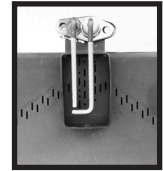

SET H3 : XL, L, M

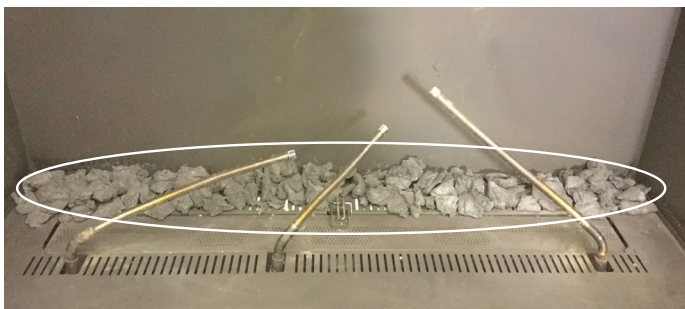
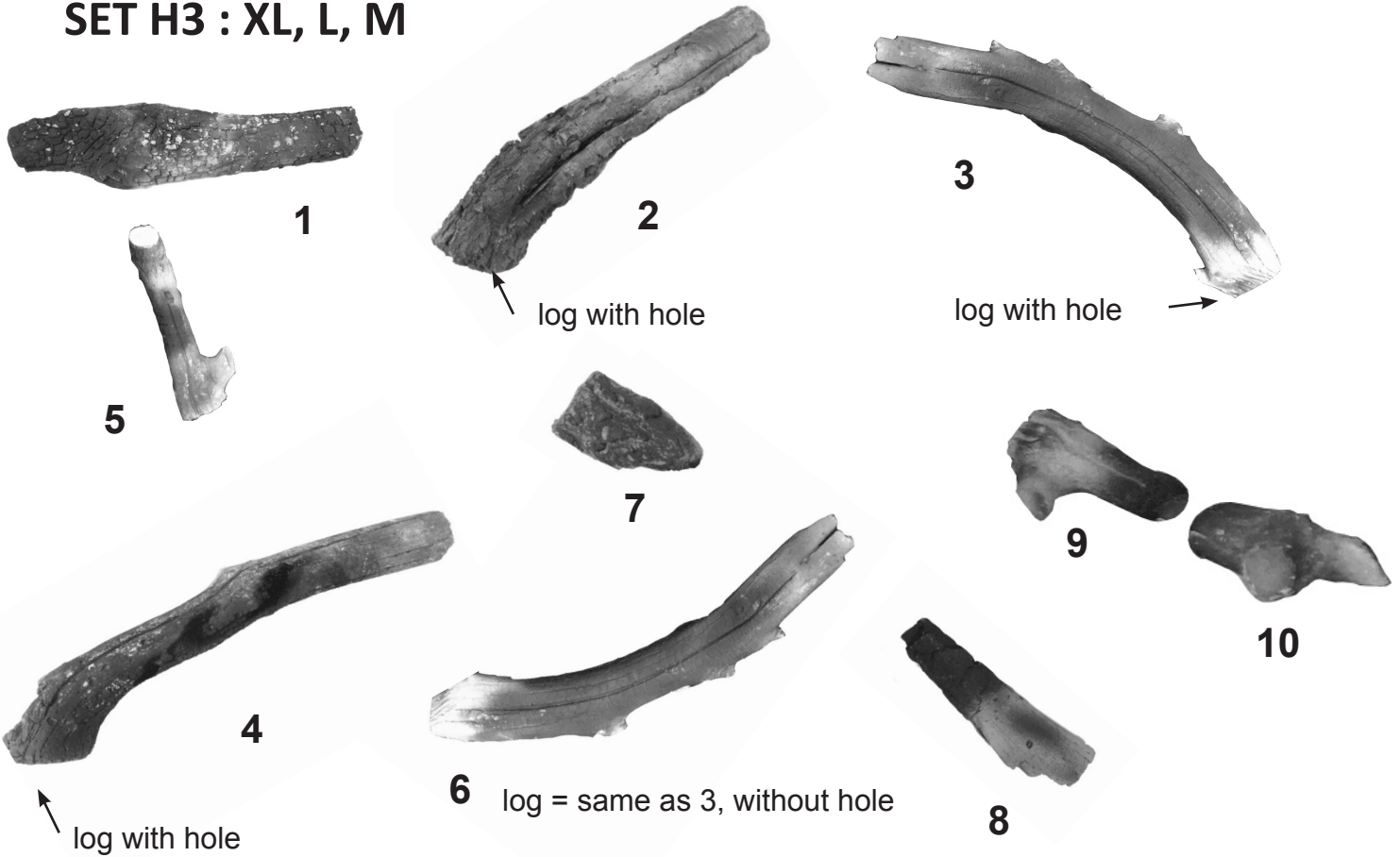

Lay a part of the imitation coal according to the photo.

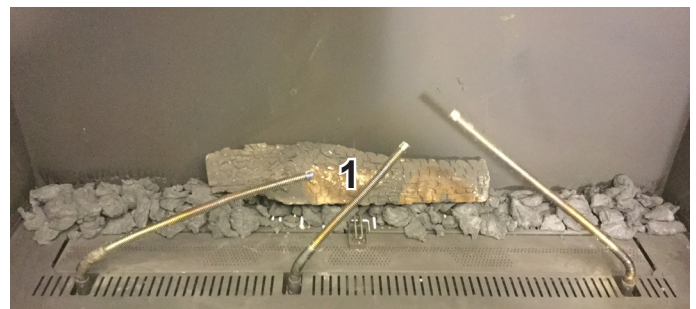

block 1

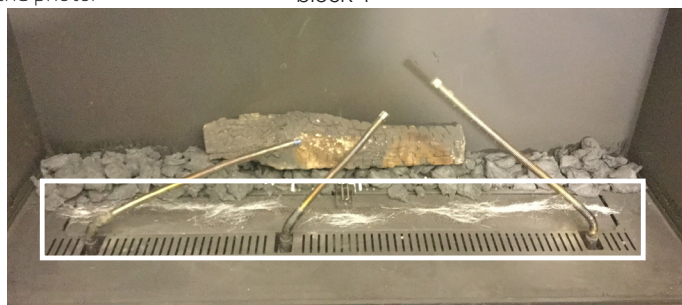

The "angel's hair" must be disentangled in length and deposit along the length of the burner according to the picture above.

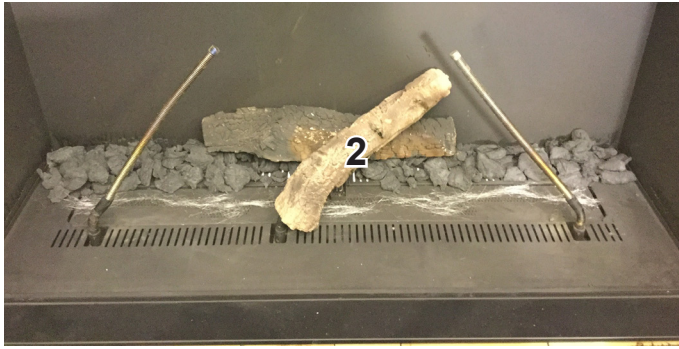

Slide block 2 (with hole) on the flexible burner



Slide block 3 (with hole) on the flexible burner



Slide block 4 (with hole) on the flexible burner



Lay imitation coal as in the picture



Put the glass wool on the "angel's hair"



block 5



block 6



block 7 and 8



block 9 (behind the window) and block 10 in front of the window (outside the fireplace)

SET H1 : SMALL

3 pakjes imitatiekolen / 3 sachets imitation charbon /
3 bags of charcoal imitation / 3 Beutel Holzkohleimitation

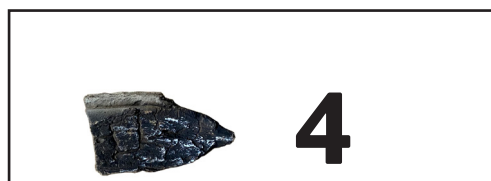



SET H2 : SMALL

3 pakjes imitatiekolen / 3 sachets imitation charbon /
3 bags of charcoal imitation / 3 Beutel Holzkohleimitation

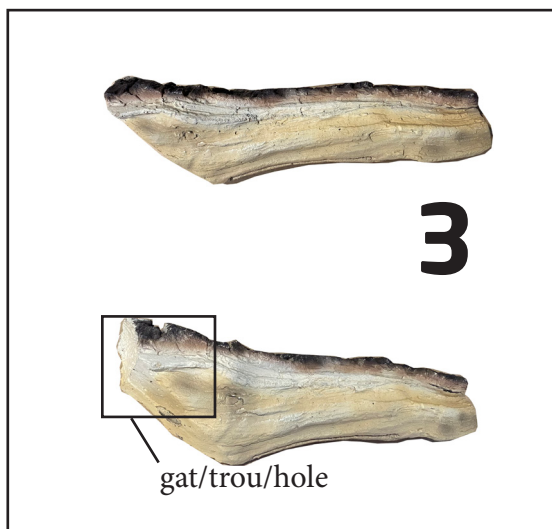
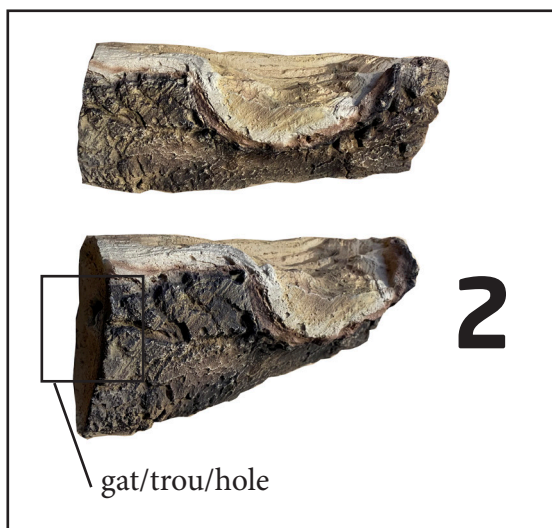



RUSTICA SMALL

Met LED / avec LED / With LED / Mit LED



As / cendre / ashes



11. DIMENSIONS XL, L, M

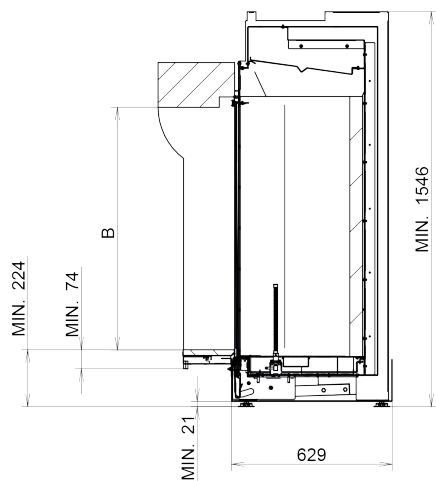

A-A

1:20

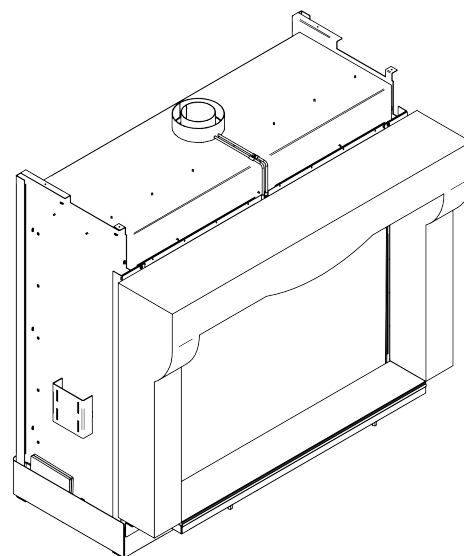
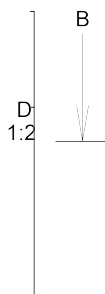
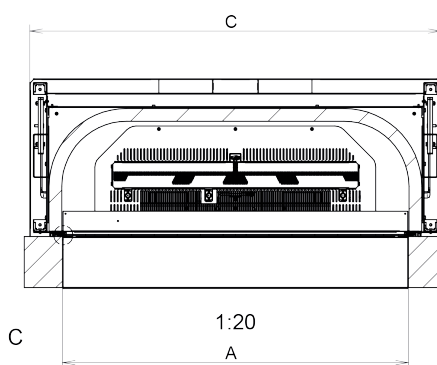
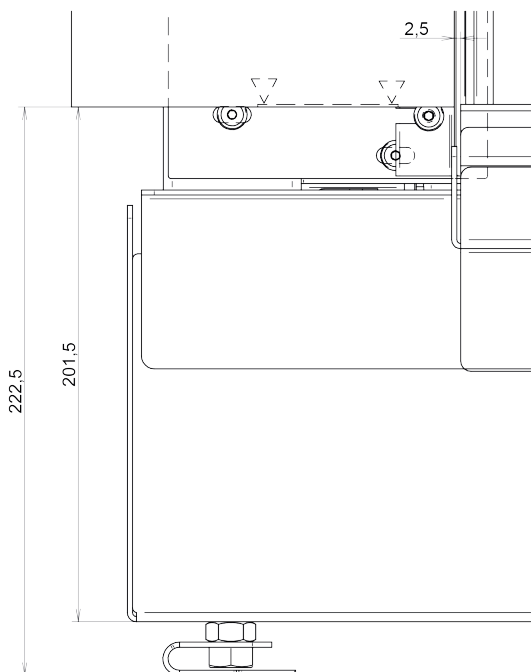
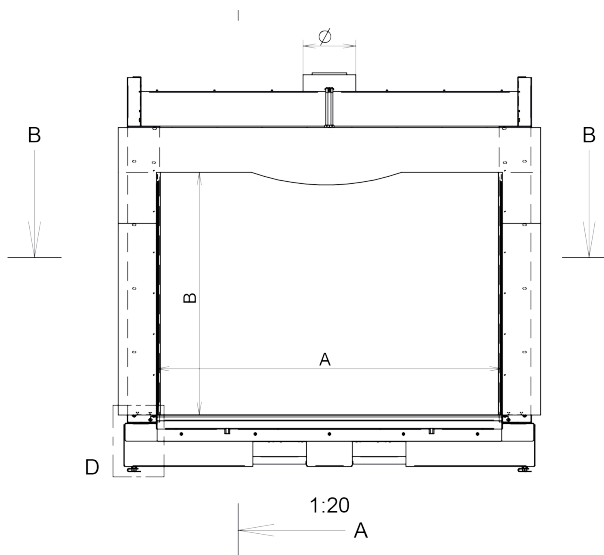

1:20

Type	A(mm)	B(mm)	C(mm)
Rustica M	850-995	800-1100	1311
Rustica L	1000-1175	800-1100	1461
Rustica XL	1180-1360	800-1100	1611

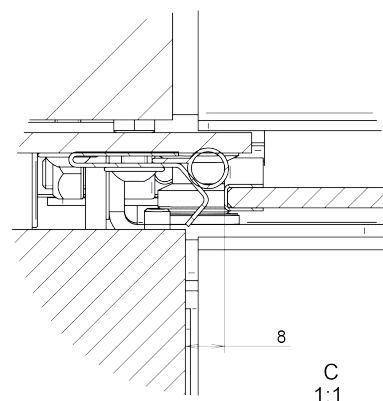

Rustica SMALL

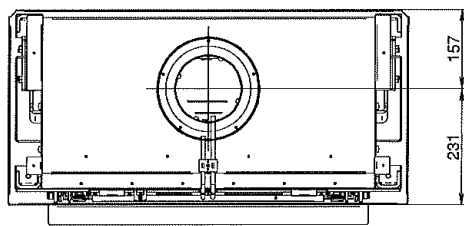
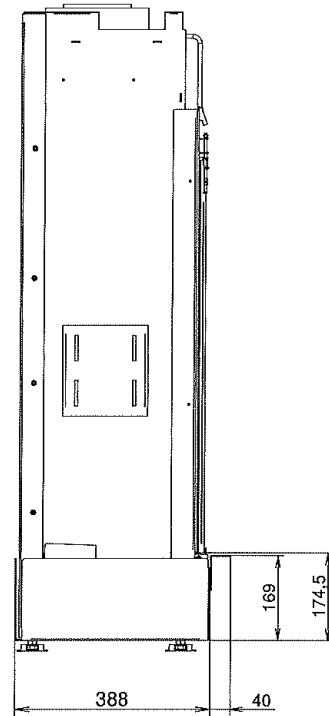
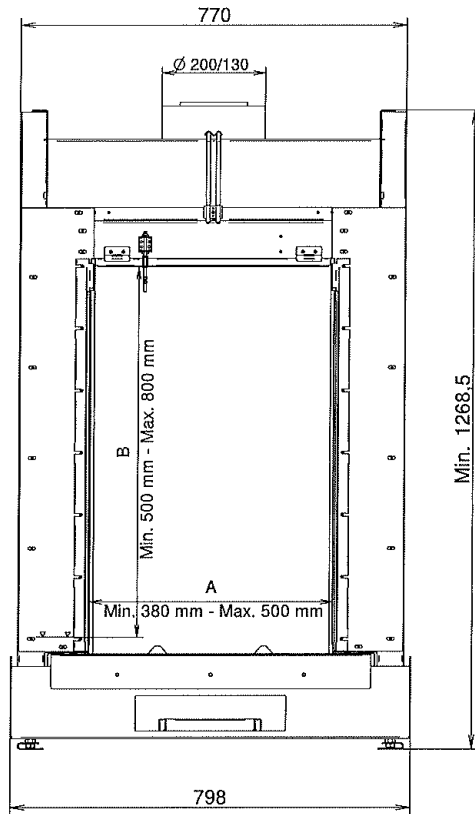

RUSTICA S

